

Quick User Guide - T1013 Eagle Transmitter

Your Video Transmitter

T1013 Transmitter

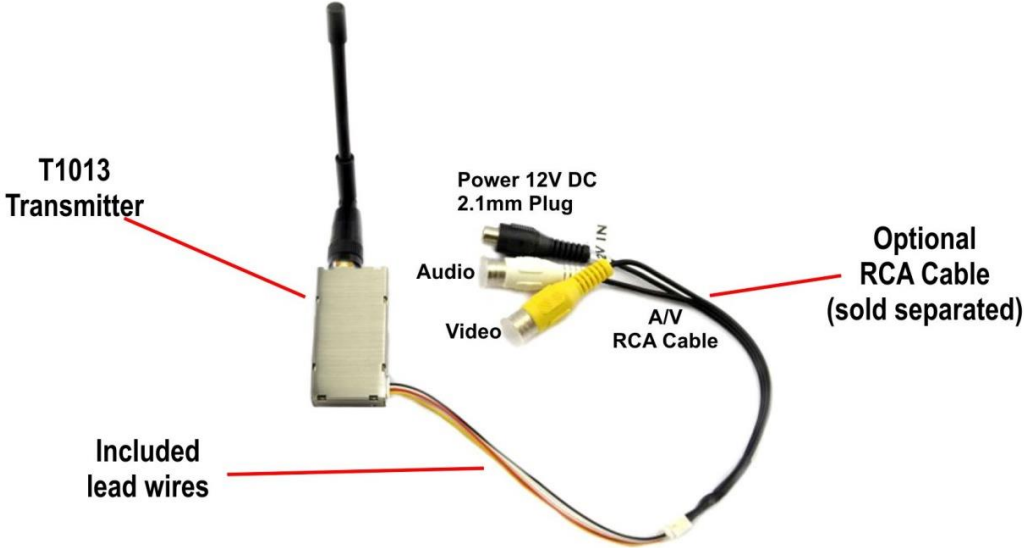

Important:

Handle with care, this transmitter can get hot.

To avoid permanent damages, do not power your transmitter with voltages that exceed 13V DC.

Your transmitter might shut off if supplied power is below 10V DC.

Do not utilize this transmitter in confined spaces without adequate air flow to prevent overheating that will cause irreversible damages.

Video Transmitter and Camera Connections

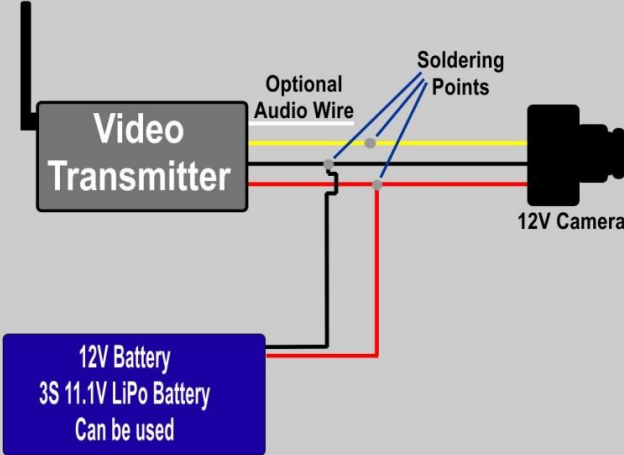

Wiring for 12V camera

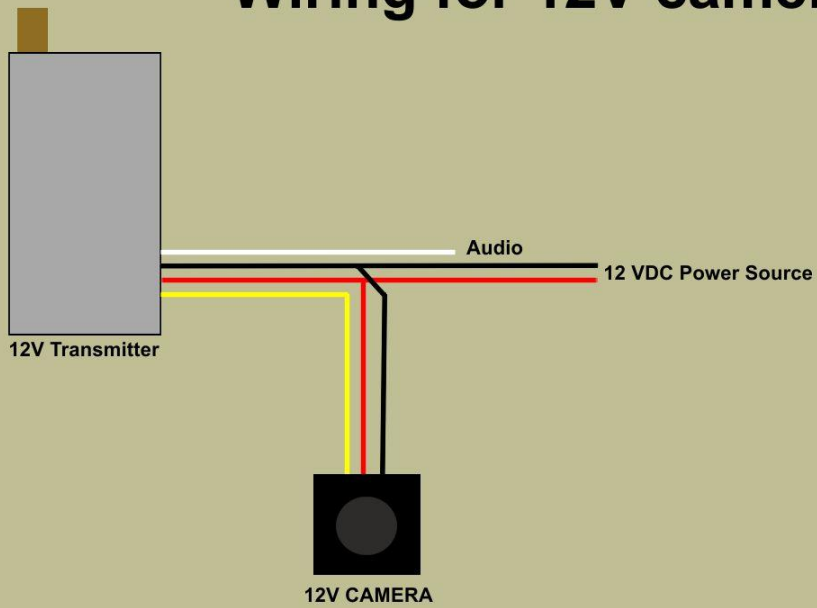

Wiring for 5V camera

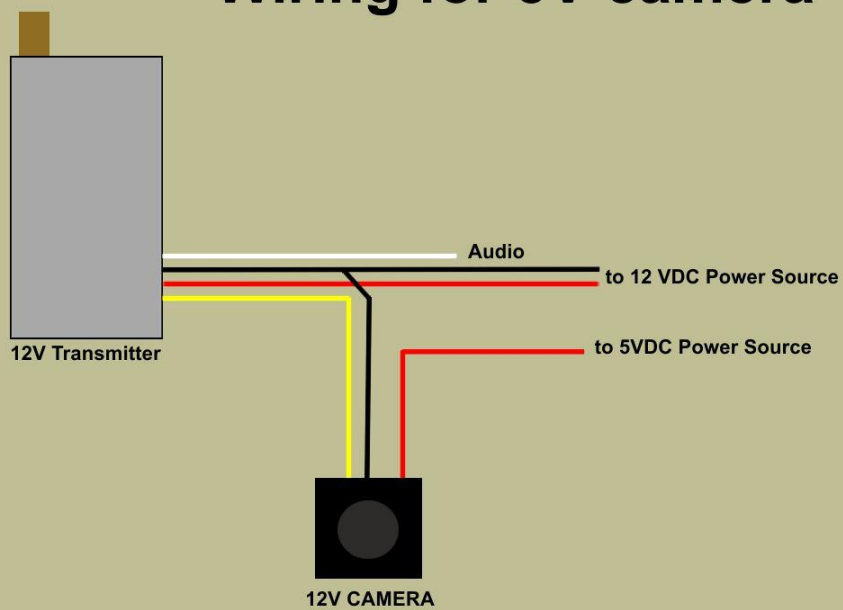

T1013 EAGLE

INTERNATIONAL VERSION

DIP SWITCHES

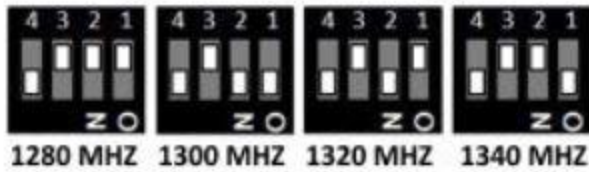
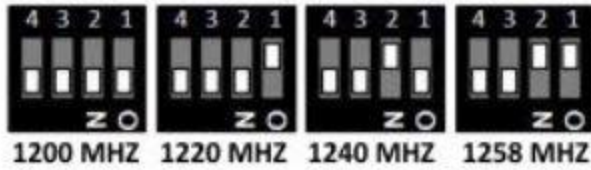

OUTPUT POWER

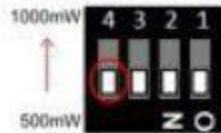

US VERSION DIP SWITCHES

